

# **USER MANUAL**

## **SHORT-CIRCUIT LOOP IMPEDANCE METERS**

**MZC-320S • MZC-330S**





## **USER MANUAL**

# **SHORT-CIRCUIT LOOP IMPEDANCE METERS MZC-320S • MZC-330S**



**SONEL S.A.  
Wokulskiego 11  
58-100 Świdnica  
Poland**

Version 1.12 20.01.2025

MZC-320S and MZC-330S meters are modern, easy in use and safe measuring devices. Please acquaint yourself with this manual in order to avoid measuring errors and prevent possible problems in operation of these meters.








## TABLE OF CONTENTS

<b>1</b>	<b>General information</b>	<b>5</b>
1.1	Safety symbols	5
1.2	Safety	6
<b>2</b>	<b>Graphical display panel (LCD)</b>	<b>8</b>
<b>3</b>	<b>Menu</b>	<b>10</b>
3.1	Display contrast adjustment	10
3.2	Display settings	10
3.3	Loop measurement settings	11
3.4	Language selection	11
3.5	Advanced functions	12
3.5.1	Expected dispersion of results	12
3.5.2	Upgrading the firmware	13
3.6	Information about the manufacturer and the software	13
<b>4</b>	<b>Measurements</b>	<b>14</b>
4.1	Conditions for performing tests and obtaining correct results	15
4.2	Remembering the last measurement result	16
4.3	Measurement of alternating voltage	16
4.4	Measurement of fault loop parameters	17
4.4.1	Measurement of network voltage and frequency	18
4.4.2	Measurement of network voltage and frequency	18
4.4.3	Displaying all measurement results or the main result only	18
4.4.4	Displaying the measurement results in terms of impedance or short-circuit current	18
4.4.5	Measurement of touch voltage $U_{ST}$ and touch shock voltage $U_T$	19
4.4.6	Selection of test cables length (for measurements using two-pole method)	21
4.4.7	Results display	21
4.4.8	Measurement of short-circuit loop parameters using two-pole method	22
4.4.9	Measurement of short-circuit loop parameters using four-pole method	24
4.4.10	measurement of earthing resistances	26
<b>5</b>	<b>Remote control of the meter</b>	<b>28</b>
<b>6</b>	<b>Saving the measurement results</b>	<b>29</b>
6.1	Storing measurement results in the memory	29
6.2	Memory browsing	30
6.3	Memory erasing	30
<b>7</b>	<b>Data transmission</b>	<b>31</b>
7.1	Set of accessories to connect the meter to a PC	31
7.2	Data transmission via USB	31
7.3	Data transmission via Bluetooth	32
7.3.1	Activation and transmission	32
7.3.2	Read-out and change of PIN code for Bluetooth	32
7.4	Data transmission using Wi-Fi	33
7.4.1	Activation of transmission	33
7.4.2	Transmission to PC software	33
7.4.3	Transmission via the network interface	34
<b>8</b>	<b>Troubleshooting</b>	<b>35</b>
8.1	Warnings and information displayed by the meter	35
8.1.1	Exceeding the measurement range	35

8.1.2	Battery status display .....	35
8.2	Self-test error messages .....	35
8.3	Before you send the device for repairs .....	36
<b>9</b>	<b>Power supply of the meter .....</b>	<b>36</b>
9.1	Power supply voltage monitoring .....	36
9.2	Charging battery .....	37
9.3	General principles for using Li-Ion rechargeable batteries .....	37
<b>10</b>	<b>Cleaning and maintenance .....</b>	<b>38</b>
<b>11</b>	<b>Storage .....</b>	<b>38</b>
<b>12</b>	<b>Dismantling and disposal .....</b>	<b>38</b>
<b>13</b>	<b>Technical specifications .....</b>	<b>38</b>
13.1	Basic data .....	38
13.2	Other technical data .....	41
13.3	Additional data .....	42
13.3.1	Additional uncertainties according to IEC 61557-3 (Z) .....	42
<b>14</b>	<b>Manufacturer .....</b>	<b>42</b>

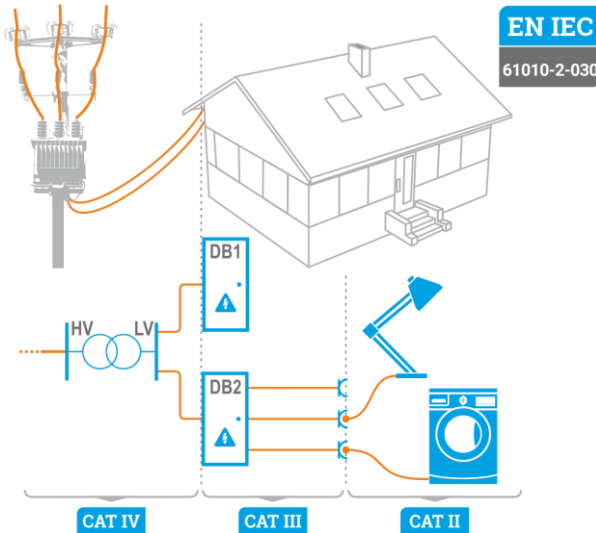
# 1 General information

## 1.1 Safety symbols

Symbols and warnings	Description
<b>NOTE</b> or <b>WARNING</b>	NOTE and WARNING messages in the following document indicate important information that should be read before using the meter.
	Triangle with an exclamation mark inside it, marked on the meter housing indicates that user must read important information in the user manual.
	The device is protected by double or reinforced insulation.
	The device is CE certified and meets the necessary European requirements.
<b>CAT IV 600 V</b> 	Measurement Category IV is applicable to test and measurement circuits connected to the source of low voltage power supply system of the building. It is expected that this part of the system will have at least one level of overcurrent protection between the transformer and the connection points of the measuring circuit. Due to the high short-circuit currents, which may be accompanied by a high level of energy, the measurements in these areas are extremely dangerous. Take all necessary precautions to avoid the risk of a short circuit. Examples include measurements on devices installed upstream the main fuse or circuit breaker of the building system. Grounding symbol at the end of the string of symbols reminds that the specified voltage is the voltage relative to the ground.
	Do not dispose of with other household waste
	AC current/voltage
	DC current/voltage

Measurement categories according to IEC 61010-2-030:

- **CAT II** – concerns measurements performed in circuits directly connected to low voltage installations,
- **CAT III** – concerns measurements performed in buildings installations,
- **CAT IV** – concerns measurements performed at the source of low voltage installation.



## 1.2 Safety

MZC-320S and MZC-330S meters are designed for performing check tests of protection against electric shock in mains systems. The meters are used for making measurements and providing results to determine safety of electrical installations. Therefore, in order to provide conditions for correct operation and accuracy of obtained results, the following recommendations must be observed:

- Before you proceed to operate the meter, acquaint yourself thoroughly with this manual and observe the safety regulations and specifications provided by the producer.
- Any application that differs from those specified in the manual may result in a damage to the device and constitute a source of danger for the user.
- MZC-320S and MZC-330S meters must be operated only by appropriately qualified personnel with relevant certificates authorizing the personnel to perform works on electric systems. Operating the meter by unauthorized personnel may result in damage to the device and constitute a source of danger for the user.
- Using this manual does not exclude the need to comply with occupational health and safety regulations and with other relevant fire regulations required during the performance of a particular type of work. Before starting the work with the device in special environments, e.g. potentially fire-risk/explosive environment, it is necessary to consult it with the person responsible for health and safety.
- It is unacceptable to operate:
  - ⇒ a damaged meter which is completely or partially out of order,
  - ⇒ a meter with damaged insulation,
  - ⇒ a meter stored for an excessive period of time in disadvantageous conditions (e.g. excessive humidity). If the meter has been transferred from a cool to a warm environment with a high level of relative humidity, do not start measurements until the meter is warmed up to the ambient temperature (approximately 30 minutes).



- One should remember that when the word **Bat!** appears on the display, it indicates insufficient voltage of power supply and the need to charge the battery. Measurements performed by means of the meter whose supply voltage is too low are burdened with additional errors that are impossible to be estimated by the user. Such measurements must not be relied on in order to state correctness of protection of a tested network.
- Before measurements may commence, make sure the leads are connected to the appropriate measurement sockets.
- Repairs may be performed only by an authorized service point.
- The correct operation of the instrument and accessories must be checked regularly to avoid any hazard which may result from erroneous results.
- In a situation where the product works with other instruments or accessories, the lowest measurement category of the connected devices is used.



### WARNING

Only standard and additional accessories for a given device should be used. Using other accessories may cause damage to measuring terminals and introduce additional measurement uncertainty.



- An attempt to install drivers in 64-bit Windows 8 and Windows 10 may result in displaying "Installation failed" message.
  - Cause: Windows 8 and Windows 10 by default blocks drivers without a digital signature.
  - Solution: Disable the driver signature enforcement in Windows.
- Due to continuous development of the meter's software, the actual appearance of the display, in case of some of the functions, may slightly differ from the display presented in this operating manual.

## 2 Graphical display panel (LCD)

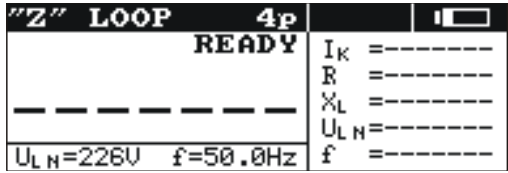


Fig. 1 Screen appearance after switching the meter on (loop impedance measurement – all results)

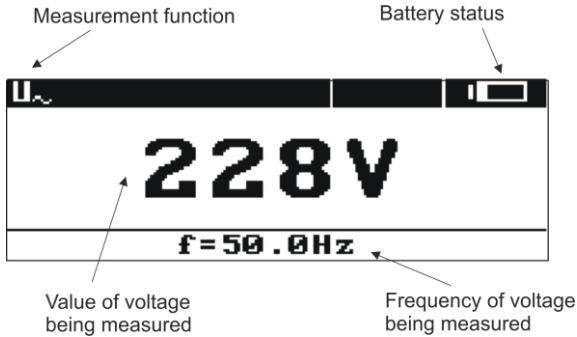


Fig. 2 Screen layout in alternating voltage measurement mode

Bank and cell number (in store-in-memory mode)  
 or the text "READY" advising about  
 the capability to make the measurement  
 or the temperature  
 excess symbol

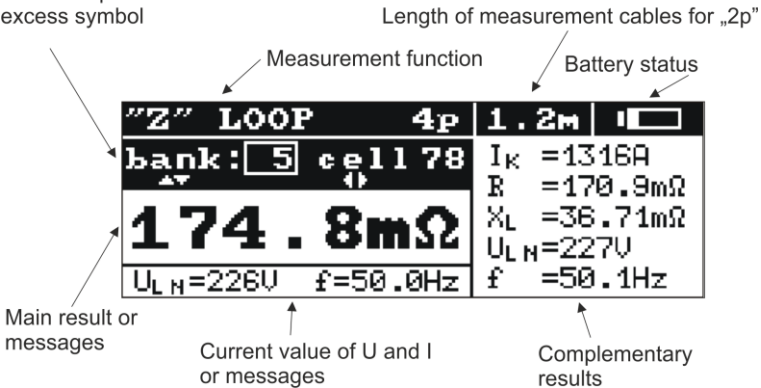
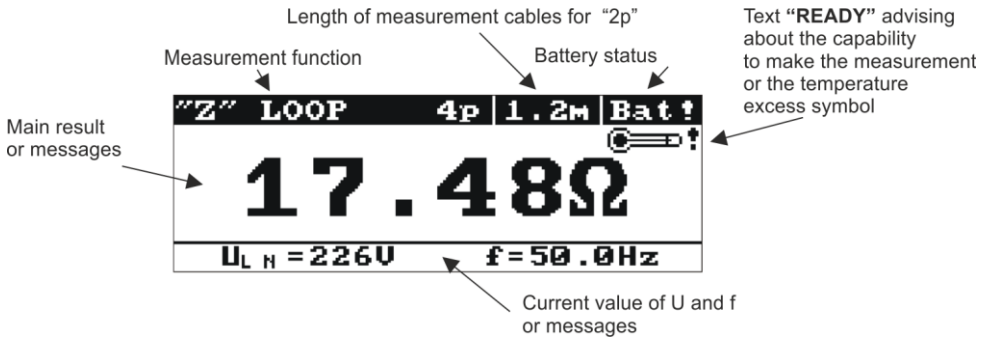
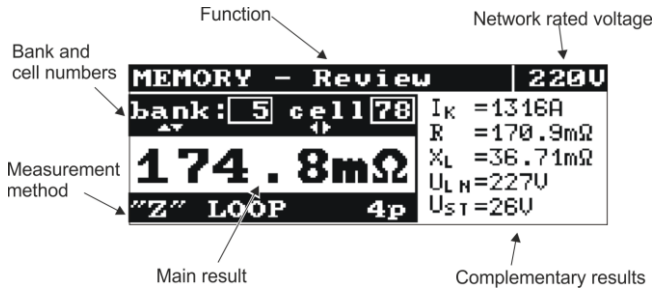


Fig. 3 Screen layout in short-circuit loop impedance measurement mode (all results)



**Fig. 4 Screen layout in short-circuit loop impedance measurement mode (main result only)**



**Fig. 5 Screen layout in the memory browse mode**

### 3 Menu

The menu is available in any position of the rotary switch with the exception of **MEM**. You can enter the menu by pressing the **MENU** key. This will give you an access to the following functions:

- adjustment of the display contrast (0...100%),
- data transmission,
- selecting the parameters to be displayed,
- setting the parameters of a loop impedance measurement ,
- language selection,
- checking the network stability and upgrading the software – advanced functions,
- obtaining basic information about the manufacturer and about the software version.

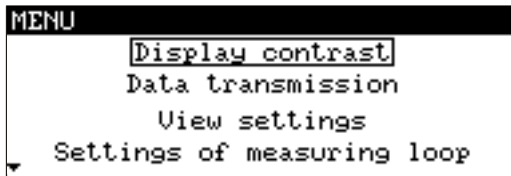


Fig. 6 Menu

#### 3.1 Display contrast adjustment

- Press the key **MENU** and **ENTER**.
- Using keys **◀** and **▶** set the required contrast.
- Press **ENTER** to confirm.
- In order to quit this option, press the key **ESC**.

#### 3.2 Display settings

In this submenu the displaying of the following parameters can be selected:

- displaying the results: all of them or  $Z_s$  ( $I_k$ ) only,
- displaying the main result in terms of  $Z_s$  or  $I_k$ .

To select parameters use the keys **▲** and **▼**. To select values use the keys **◀** and **▶**. In order to confirm changes to the settings, select **Save?** and the select **YES** and press the key **ENTER**.

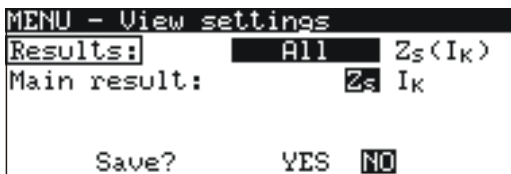


Fig. 7 Display settings

### 3.3 Loop measurement settings

In this submenu the following parameters can be set:

- network rated voltage  $U_n$  (110/190 V, 115/200 V, 127/220 V, 220/380 V, 230/400 V, 240/415 V, 290/500 V i 400/690 V (only MZC-330S)),
- length of cables in the measurement of short-circuit loop parameters using a two-pole method (2p),
- measurement of touch voltage  $U_{ST}$  or touch shock voltage  $U_T$  (and their displaying instead of frequency in the column of auxiliary results).

The selection is made as described in sec. 3.2.

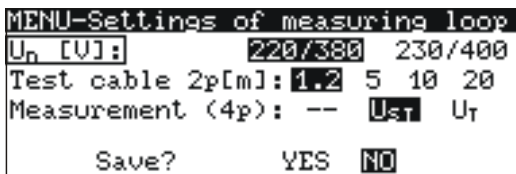


Fig. 8 Loop measurement settings

When selecting the nominal voltage, with the **ENTER** key a drop-down menu will appear, in which the selection is made with the **▲** and **▼** keys.

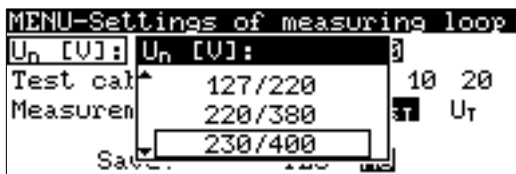


Fig. 9 Mains nominal voltage selection

### 3.4 Language selection

Submenu **Language**, enables the user to select a language that the device will use to display all text.

## 3.5 Advanced functions

### 3.5.1 Expected dispersion of results

If the result of the short-circuit loop impedance measurement diverges from an anticipated value or there is no consistency of results within a series of measurements made, you may use the function **Expected declension (Dispersion)**. This function can be used to assess errors of loop impedance measurements resulting from the voltage instability at a given measurement point (thus independent of the device parameters). The device (set and connected to the network as for the measurements of short-circuit loop impedance – 2p or 4p) performs the analysis and on its basis it computes the errors values that might additionally burden short-circuit loop impedance measurements.



The function applies to the most recent measurement result only and does not apply to Alternating voltage measurement.

After entering this option a short message describing its functionality and a recommendation to get familiarized with this instruction is displayed. After electing **YES** and pressing the key **ENTER**, a picture shown on **Fig. 10** (for the 4p method) is displayed.

```
MENU-Expected declension
ULN=230V    f=50.0Hz
ΔZ = ± ---.- mΩ
Exit  Measurement
```

**Fig. 10 Estimation of short circuit loop impedance measurement errors due to mains voltage instability**

At the top of the screen the values of the currently tested network voltage and frequency are displayed. Underneath the calculated estimate of the error for the measurement method to which the meter is presently set is presented.

In order to start the measurement, select **Measurement** and press the key **ENTER**. The message **Wait, the measurement is going on** and a progress bar will be displayed. When the measurement is completed, the result will be shown (on the picture – instead of horizontal lines). By pressing the key **ENTER** again another measurement will be initiated.

To quit this option, select **Exit** and then press the key **ENTER**. You can also use the key **ESC**.

## 3.5.2 Upgrading the firmware



### NOTE!

Charge the batteries before programming. The user must not turn off the meter nor disconnect the communications cables during the procedure.



- During the programming operation the keyboard (except for key ON/OFF) is inoperative. In this function the meter does not switch off automatically.
- Instruments equipped with a Wi-Fi module do not support updating via USB.

### 3.5.2.1 Upgrade via USB

- Download the firmware from the manufacturer's website.
- Connect the meter to the PC.
- On the device menu select the function **Software upgrade** and confirm that you have read the information displayed.
- Install and then launch the software on the PC.
- Select the port in the program, activate the option „Connection test” and then start the option „Programming”.
- Follow the instructions displayed by the software.

### 3.5.2.2 Upgrade via Wi-Fi

- Connect the meter to a Wi-Fi network with Internet access (**sec. 7.4.1**).
- On the device menu select the function **Software upgrade** and confirm that you have read the information displayed.
- Follow the instructions.

## 3.6 Information about the manufacturer and the software

By activating this submenu, the user may obtain the basic information about the meter manufacturer and the software version.

## 4 Measurements



### WARNING

- During measurements, the earthed parts and parts accessible in the electrical installation being tested must not be touched.
- During a measurement, switching of the range switch is forbidden because it may damage the meter and pose a threat to the user.
- Connecting unsuitable or faulty cables can cause an electrical shock.



### NOTE!

MZC-320S and MZC-330S meters are designed to operate at rated phase and inter-phase voltages of 110/190 V, 115/200 V, 127/220 V, 220/380 V, 230/400 V, 240/415 V, 290/500 V, 400/690 V (only MZC-330S).

Applying voltages higher than 550 V for MZC-320S or 750 V for MZC-330S to any of the test terminals can damage the device.





- The manufacturer guarantees correct readings only if the original leads supplied with the device are used and if the correct length (for 2p method) has been selected in the MENU. Extension leads or third party cables can be a source of additional errors.
- Symbol “CAT III 1000 V” shown on accessories is equivalent to the symbol “CAT IV 600 V”.



## 4.1 Conditions for performing tests and obtaining correct results

To start a test sequence a number of conditions have to be fulfilled. The device will automatically prevent a test from commencing (except for voltage measurement) if any of the conditions listed below is not satisfied:

Situation	Displayed symbols and warning signals	Remarks
The voltage applied to meter's terminals exceeds 550 V (750 V for MZC-330S).	Text: <b>U &gt; 550V!</b> ( <b>U &gt; 750V!</b> for MZC-330S) and a continuous beep produced.	Immediately disconnect the meter from the tested installation!
The voltage frequency in the installation is outside of the range 45 Hz..65 Hz.	Texts: <b>Error!</b> and: <b>f&lt;45Hz</b> or <b>f&gt;65Hz</b> Two long beeps.	The text appears and a sound signal is produced when the key <b>START</b> is pressed.
The voltage applied to meter's terminals is too low to measure the impedance.	Texts: <b>Error!</b> and: <b>U.&lt;95V</b> Two long beeps.	The text appears and a sound signal is produced when the key <b>START</b> is pressed.
Improperly connected cable I1: in 4p method to socket I1 2p or in 2p method to socket I1 4p.	Texts: <b>Cables connected improperly!</b> and: <b>Terminal I1 (2p)!</b> or <b>Terminal I1 (4p)!</b> Two long beeps.	The text appears and a sound signal is produced when the key <b>START</b> is pressed.
Cables I1 or I2 are not connected (in the 4p method).	Text: <b>No voltage on terminals I1, I2!</b> Two long beeps.	The text appears and a sound signal is produced when the key <b>START</b> .
In the 4 p method, cables U or I swapped, or connected to different phases.	Text: <b>Different voltage phases on terminals U and I!</b> Two long beeps.	The text appears and a sound signal is produced when the key <b>START</b> is pressed.
Improperly connected cable U <sub>B</sub> with the set option of touch voltage measurement.	Texts: <b>Incorrectly connected cable!</b> and: <b>Terminal U<sub>B</sub>!</b> Two long beeps	The text appears and a sound signal is produced when the key <b>START</b> is pressed.
While measuring the loop impedance a voltage drop below U <sub>min</sub> took place.	Text: <b>Voltage failure while measuring!</b> Two long beeps.	
While measuring the loop impedance a situation preventing completion of the measurement occurred.	Text: <b>Error while measuring!</b> Two long beeps.	
While measuring the loop impedance the fuse was burnt or another emergency situation in the current circuit occurred.	Text: <b>Short circuit loop faulty!</b> Two long beeps.	
Thermal protection prevents the measurement.	Displayed symbol  Long beep.	A sound signal is produced when the key <b>START</b> is pressed
Exceeded measurement range.	Inscription: <b>OFL</b> Two long beeps.	
Discharged battery.	Displayed symbol  Two long beeps.	Making the measurements is still possible, however, the user should take into account some additional errors.



Displayed warnings stay on the screen for 3 seconds.

## 4.2 Remembering the last measurement result

The result of the latest measurement is remembered by the meter until a next measurement is started or measurement settings are changed or the measuring function is changed by means of the rotary switch. When you go to the voltage measurement screen with the **ESC** button, you can recall this result by pressing **ENTER**. Use the same button to recall the last result after powering the meter off and on (if the position of function selector has not been changed).

## 4.3 Measurement of alternating voltage



### NOTE!

Applying voltage in excess of 550 V (750 V for MZC-330S) to any of the test terminals may damage the device.

To measure alternating voltage:

- Connect the test cables to sockets: **U<sub>1</sub>** and **U<sub>2</sub>** (Fig. 11)
- Set the rotary switch to position **U<sub>~</sub>**

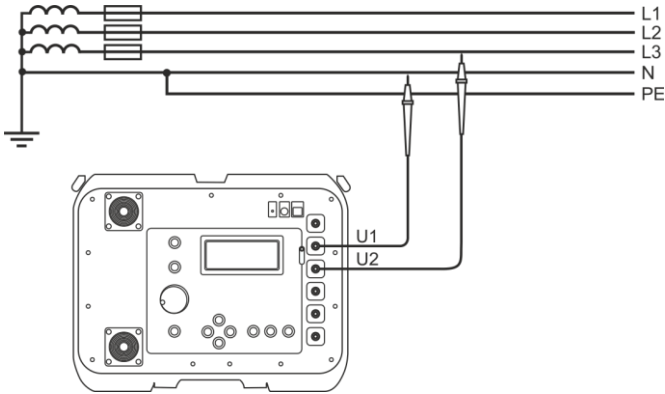


Fig. 11 Alternating voltage measurement

The measurement result is displayed as shown on Fig. 12:

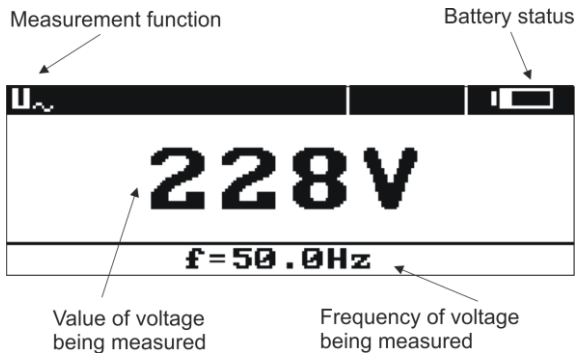


Fig. 12 Alternating voltage measurement – result

The instrument measures alternating voltage with the frequency between 45Hz and 65Hz as True RMS without separating a possible constant component. Voltage with the frequency lower than 45Hz is measured as direct voltage. If the frequency of the run being measured is not included within the specified limits, instead of its value an appropriate message is displayed: **f<45Hz** or **f>65Hz**.

## 4.4 Measurement of fault loop parameters



### WARNING

- **You must not leave disconnected leads while some of them remains connected to the tested installation.**
- **You must not leave the device unattended while it is connected to the tested installation.**
- **You must not touch appliances connected to the tested installation.**



### NOTE!

- If the tested installation includes RCD circuit breakers, you should bridge them for the duration of the test. You should keep in mind however that doing so you modify the tested circuit and consequently the results can marginally differ from the expected results.
- Remember to remove any modifications of the installations that were introduced and check the functioning of the RCD circuit breakers.
- Attention should be paid to the correct selection of test terminals since the precision of the measurements being performed depends upon the quality of connections made. They have to provide a good contact and allow for undisturbed flow of high current measured. For instance, it is unacceptable to clip the crocodile connectors onto oxidized or corroded points – they have to be either cleaned beforehand, or the test needle tip probe should be used for measurements.



- Performing a large number of consecutive measurements in short intervals can cause the resistor limiting the current flowing through the device to produce large amounts of heat which in turn can cause the device's housing to become hot. This is quite normal. The device has a built-in overheating protection.
- During measurements with a current of an order of 300 A, the instrument, if necessary, activates a fan that reduces the instrument cool-down time.
- The minimum time interval between successive measurements is 5 seconds. The text „READY” displayed on the screen informs the user that the device is ready to perform the measurement.

#### 4.4.1 Measurement of network voltage and frequency

In the short-circuit loop parameters measurement (2p or 4p) mode, the instrument constantly monitors the network voltage and frequency in the way described in sec. 4.3. Their values are displayed at the bottom of the screen. Index attached to the voltage U symbol informs the user whether the phase voltage -  $U_{LN}$ , or the inter-phase voltage -  $U_{LL}$  is measured, or whether the voltage value exceeds the ranges shown in **Fig. 13** -  $U_{\sim}$ . The same rules to determine the voltage type apply to the voltage measured while measuring the short-circuit loop impedance.

#### 4.4.2 Measurement of network voltage and frequency

The rated voltage is used to compute the short-circuit voltage value. In order to set the voltage rated value do the following:

- press down the key **MENU**,
- select **Loop measurement settings**
- in the item  **$U_n[V]$**  select and store the rated voltage value (see sec. 3.3).

#### 4.4.3 Displaying all measurement results or the main result only

In order to choose between displaying all measurement results or the main result only ( $Z_s$  or  $I_k$ ) you need to:

- press the key **MENU**,
- select **Display settings**,
- in the item **Results** select and store the option required (see sec. 3.3).

#### 4.4.4 Displaying the measurement results in terms of impedance or short-circuit current

The main result of the measurement can be displayed as a short-circuit loop impedance or a short-circuit current. If the impedance has been selected, the first of the auxiliary results will be the current, otherwise it will be the impedance. To select the value to be displayed you need to:

- press the key **MENU**,
- select **Display settings**,
- in the **Main result** option select and save the value type to be displayed (see sec. 3.3).

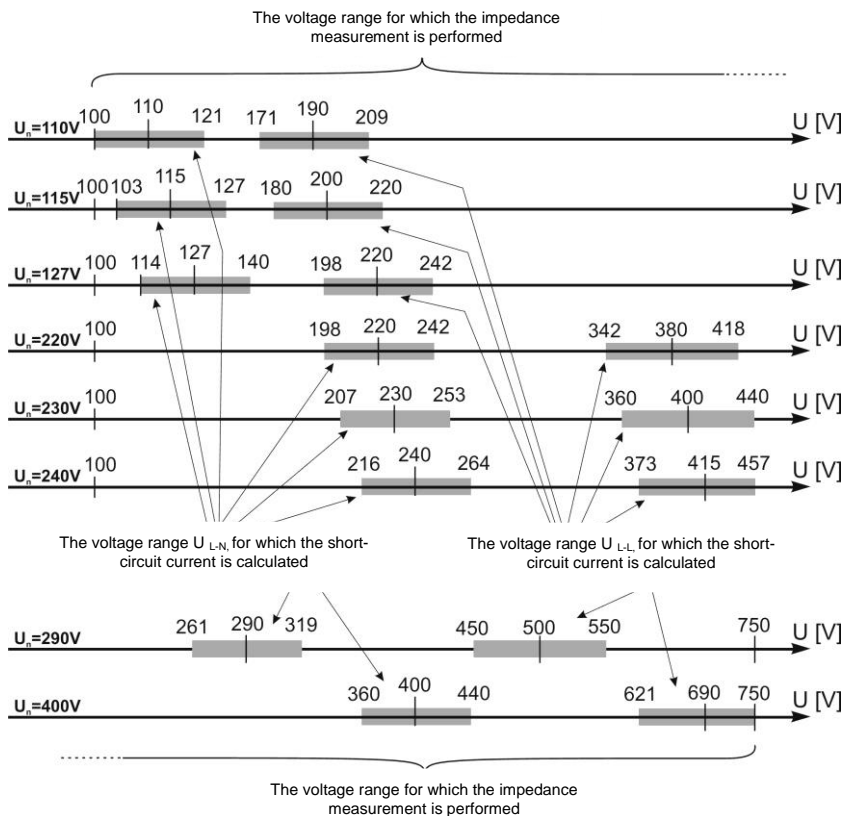
The device always measures impedance, and the short-circuit current displayed is calculated from the formula:

$$I_k = \frac{U_n}{Z_s}$$

where:  $U_n$  – rated voltage of the network being tested,  $Z_s$  – impedance measured.

The meter automatically recognizes the measurement for line voltage and takes it into account in calculations.

In a case when the installation voltage is outside of tolerance, the meter will not be able to determine the rated voltage for the short-circuit current calculation. In such event the display will show horizontal dashes instead of the short-circuit current value. Figure below shows voltage ranges for which the short-circuit current is calculated.



**Fig. 13 Relationship between the network voltage and the ability to calculate the short-circuit current**

Further in this document the term „impedance measurement” will refer to performing the measurement and displaying the result in terms of current or impedance.

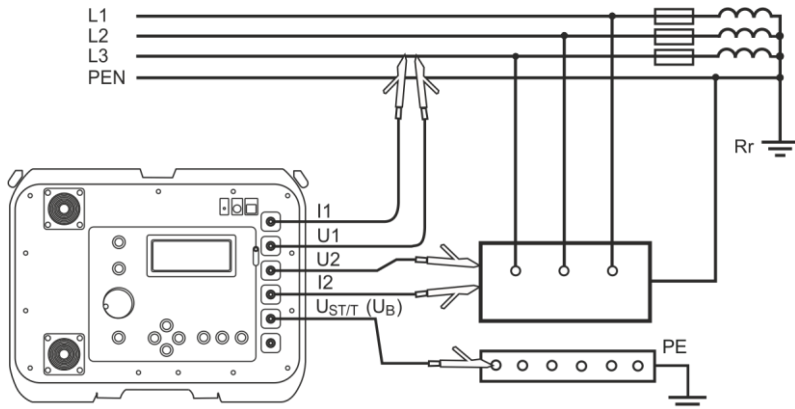
#### 4.4.5 Measurement of touch voltage $U_{ST}$ and touch shock voltage $U_T$



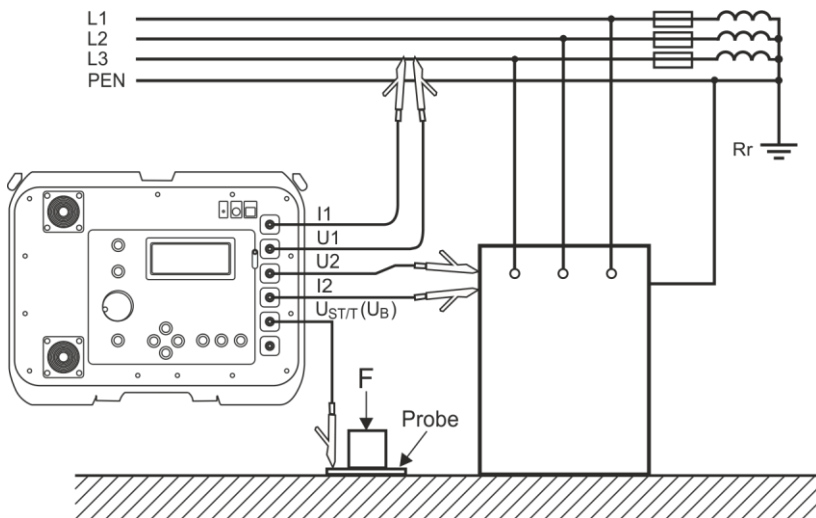
Touch shock voltage  $U_T$  as measured by the meter applies to the network rated voltage for which the measurement was made. For other rated voltages the result displayed should be converted.

In order to measure touch voltage  $U_{ST}$  or touch shock voltage  $U_T$  you need to:

- press the key **MENU**,
- select **Loop parameters settings**,
- in the item **Measurement (4p)**, select  $U_{ST}$  or  $U_T$  and save the selection (see sec. 3.3),
- connect test leads according to Fig. 14 or Fig. 15:



**Fig. 14 Measurement of touch voltage  $U_{ST}$**



**Fig. 15 Measurement of shock voltage  $U_T$**



If touch voltage is not measured, the user should, in MENU item „Measurement (4p)”, select and save the „- -” option. Otherwise the displayed values will not be correct since they can induce interfering voltages in unconnected socket  $U_{ST/T} (U_B)$ .

The value of touch voltage  $U_{ST}$  (or touch shock voltage  $U_T$ ), being the value referred to the anticipated short-circuit current calculated from the formula as presented in sec. 4.4.4, is displayed instead of frequency in the auxiliary results field (Fig. 5).

The measurement of touch shock voltage  $U_T$  is performed after introducing an additional resistor (inside the device) of  $1\text{ k}\Omega$  between the terminals  $U_2$  and  $U_{ST/T} (U_B)$ . The resistor simulates resistance of the human body, while the terminal  $U_{ST/T} (U_B)$  is to be connected to the probe that simulates human feet located on the ground (Fig. 15), whose properties and load are described by relevant standards.

## 4.4.6 Selection of test cables length (for measurements using two-pole method)

Before starting a measurement, a correct length of test leads should be selected.



### NOTE!

Using the proper test leads and the correct length selection guarantees that the declared accuracy of measurements will be maintained.



- It is assumed that only one test lead has the length selected in the MENU. The other one is always 1.2 m in length.
- Non-compliance with this assumption will cause additional measurement errors (test leads resistance is always taken into account by the device).

In order to select the length of cables, you need to:

- press the key **MENU**,
- select **Loop measurement parameters**,
- in the item **2p lead [m]**, select and save an appropriate value (see sec. 3.3).

## 4.4.7 Results display

If display of all results was selected, the short-circuit impedance  $Z_S$  or expected short-circuit current  $I_K$  is shown as the main result. On the right hand side of the screen the measurement components are displayed:

- short-circuit current  $I_K$  or  $Z_S$ ,
- resistance  $R$ ,
- reactance  $X_L$ ,

as well as:

- mains voltage at the time of the measurement ( $U_{LN}$ ,  $U_{LL}$ ,  $U_{LPE}$  or  $U_{-}$ ),
- frequency at the time of the touch (shock voltage) measurement.

An example of a display after a short-circuit loop measurement was performed is shown in Fig. 16.

"Z" LOOP	4p	
<b>174.8mΩ</b>		$I_K = 1316A$
		$R = 170.9mΩ$
		$X_L = 36.71mΩ$
		$U_{LN} = 227V$
$U_{LN} = 226V$	$f = 50.0Hz$	$f = 50.1Hz$

Fig. 16 Displaying the results of short-circuit loop parameters measurement

If displaying of the main result only has been selected, the layout of the screen is as shown on Fig. 4.

#### 4.4.8 Measurement of short-circuit loop parameters using two-pole method

This is a measurement involving a current with a value of up to 30 A (MZC-320S) or up to 40 A (MZC-330S). To make the measurement you need to:

- connect the test leads to the sockets:  $I_1$  (**2p**) and  $I_2$  (Fig. 17-Fig. 20),
- set the rotary switch to the position **2p**,
- press the key **START**.

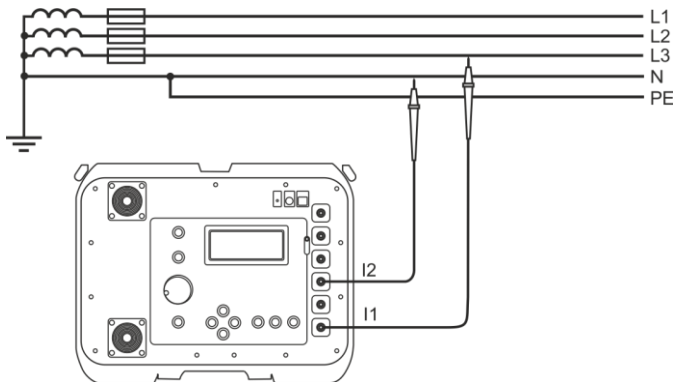


Fig. 17 Measurement of impedance in working circuit (L-N) using two-pole method

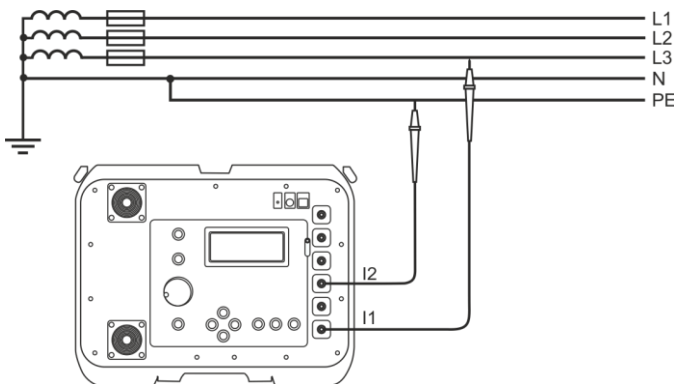
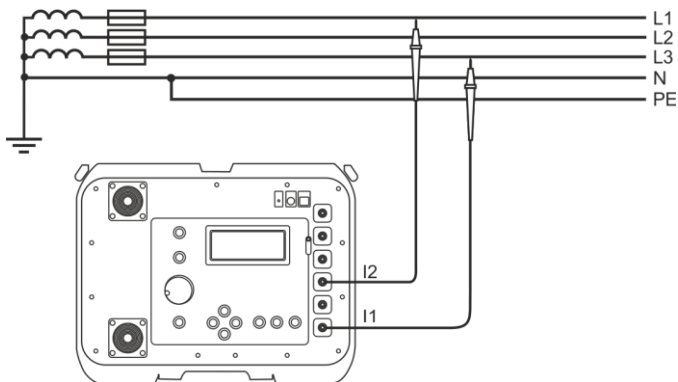


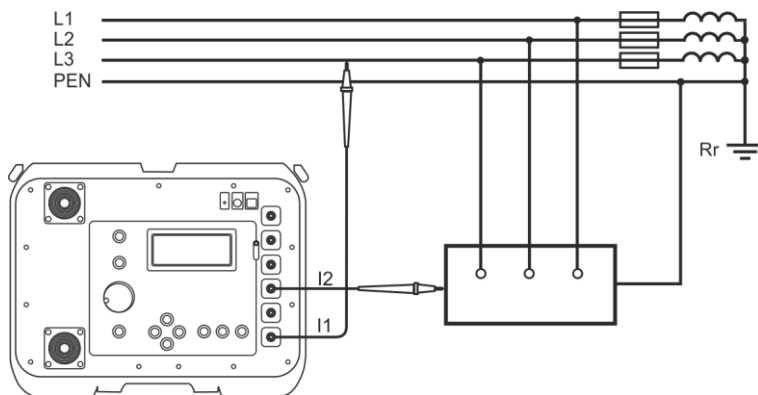
Fig. 18 Measurement of impedance in protective circuit (L-PE) using two-pole method



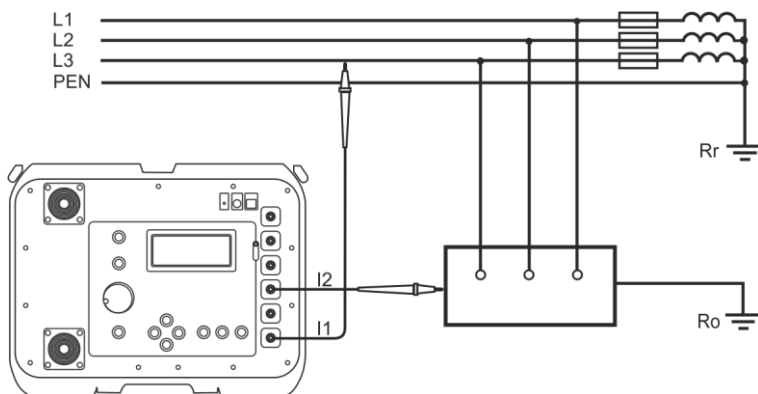


**Fig. 19 Measurement of impedance in working circuit (L-L) using two-pole method**

a)



b)



**Fig. 20 Verification of anti-shock protection reliability of appliance's housing using two-pole method for: a) TN networks b) TT networks**

## 4.4.9 Measurement of short-circuit loop parameters using four-pole method



### WARNING

Use caution when operating the device as hot air that can be expelled by the built-in fan.

This is a measurement involving the current with a value of up to 300 A (1.5  $\Omega$  short-circuit resistor, 2  $\Omega$  measurement range). It is specifically designed for circuits with very low short-circuit loop impedance. To make the measurement you need to:

- connect the test leads in the following way (Fig. 21-Fig. 24):
  - current leads to sockets: **I<sub>1</sub> (4p)** and **I<sub>2</sub>**,
  - voltage leads to sockets: **U<sub>1</sub>** and **U<sub>2</sub>**,
- set the rotary switch to the position **4p (I<sub>max</sub> = 300A)**,
- press the key **START**.

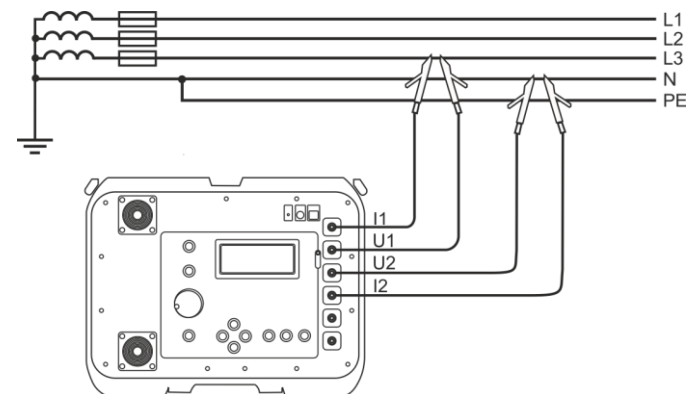


Fig. 21 Measurement of impedance in working circuit (L-N) using four-pole method

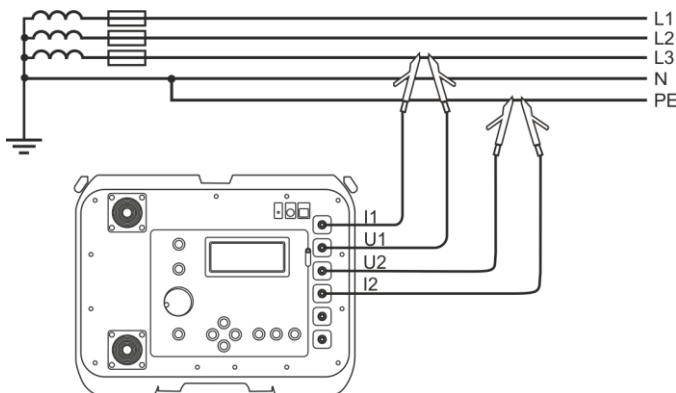
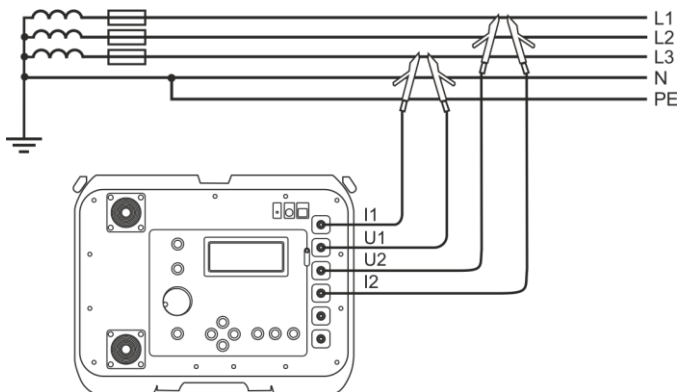
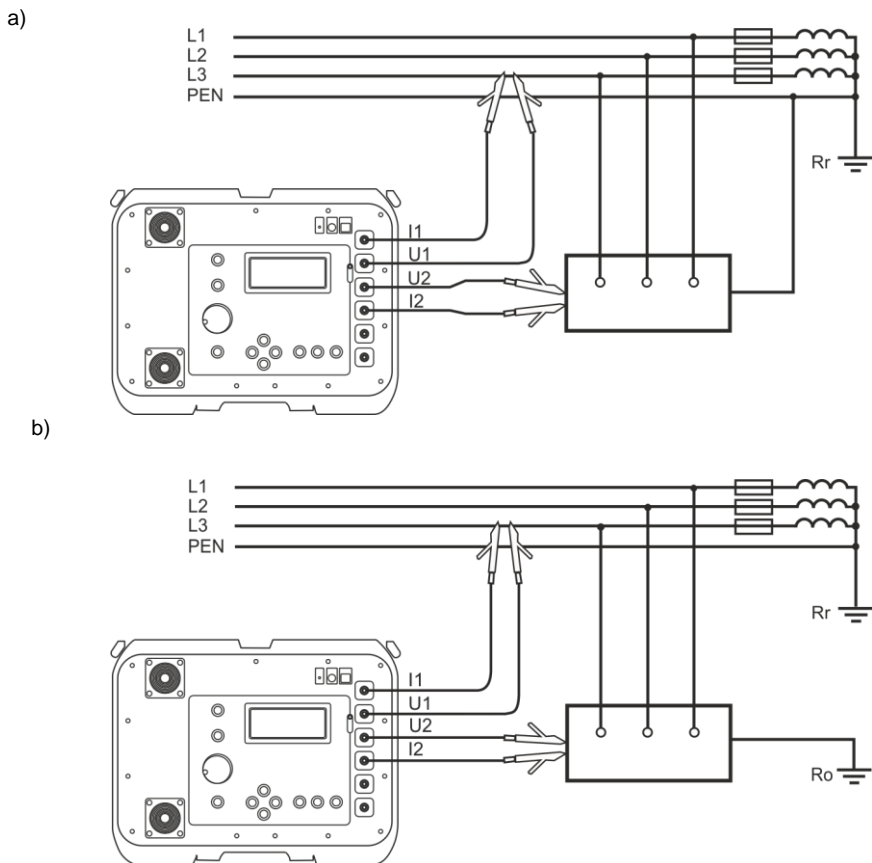


Fig. 22 Measurement of impedance in protective circuit (L-PE) using four-pole method



**Fig. 23 Measurement of impedance in working circuit (L-L) using four-pole method**

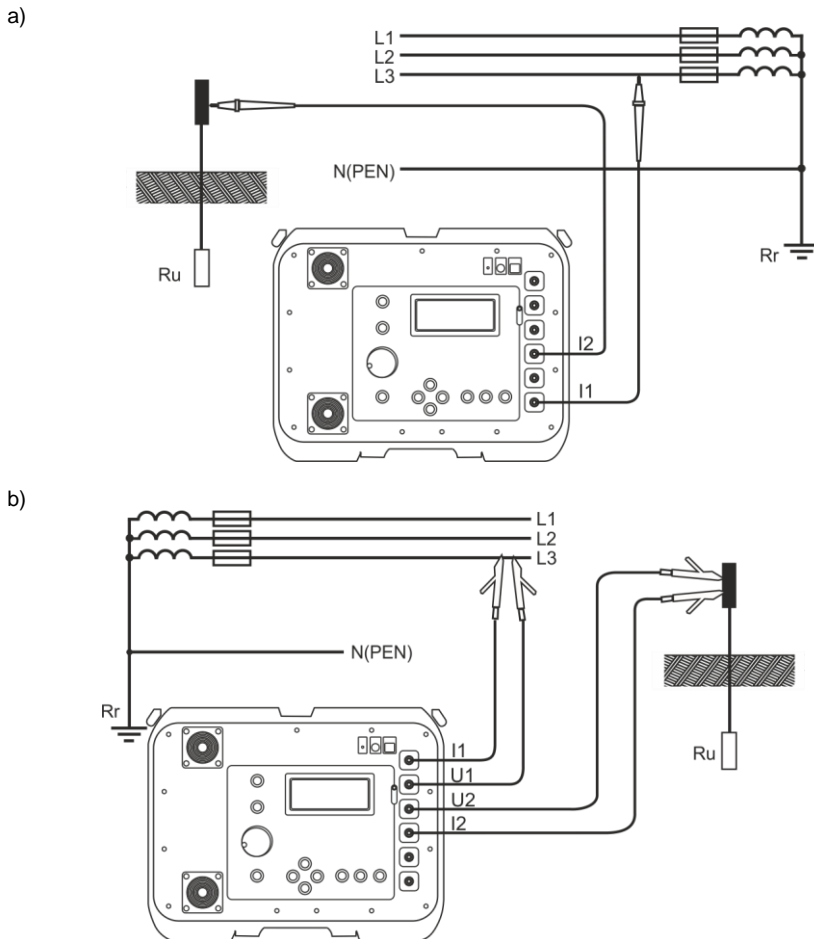


**Fig. 24 Verification of the anti-shock protection reliability of appliance's housing using four-pole method for: a) TN networks b) TT networks**

## 4.4.10 measurement of earthing resistances

MZC-320S and MZC-330S meters can be used for rough measurements of earthing impedance and resistance. To do this, use the installation phase cable as an auxiliary voltage source – see Fig. 25.

The measurement result is the sum of resistances of the earth electrode, working grounding, source and phase cable, thus it is burdened with a positive error. However, if it does not exceed the value allowable for the grounding being tested, the user may accept that the grounding has been made correctly and that there is no need to use more accurate measurement methods.



**Fig. 25 Method of connecting MZC-320S (MZC-330S) when measuring the grounding resistance for TN-C, TN-S and TT : a) using two-pole method b) using four-pole method**

During earth resistance measurement it is necessary to familiarize with existing scheme of earth systems. To receive correct results, earth system should be disconnected from the network (N and PE cables). To measure earthing system in TN-C-S system and simultaneously to use the phase as the current source it is necessary to disconnect PE and N cable from measured earthing system (**Fig. 26**),

otherwise the meter will measure an incorrect value (test current will flow not only through the grounding system).

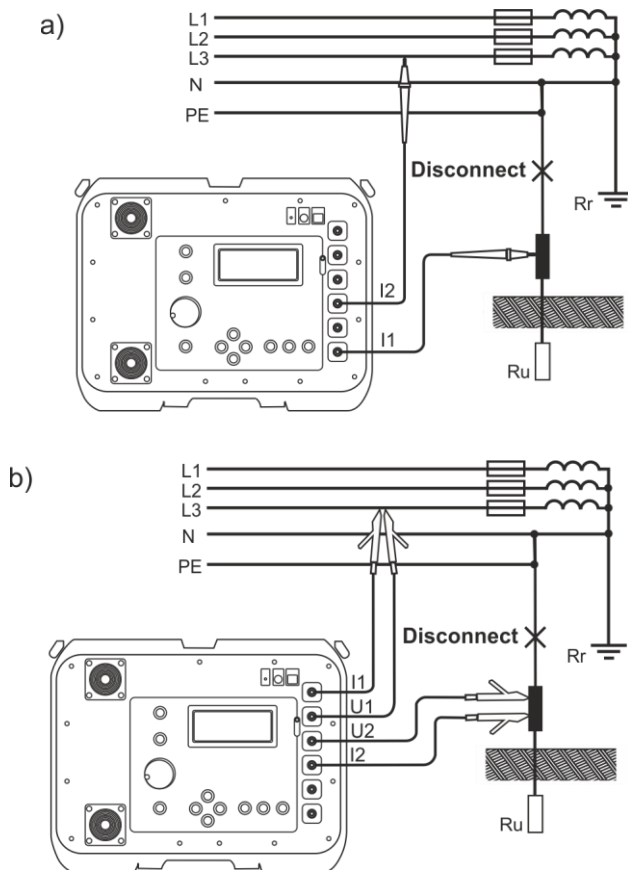


Fig. 26 MZC-320S and MZC-330S connection diagram to be used when measuring the earth resistance for TN-C-S a) using two-pole method b) using four-pole method



**WARNING**

Disconnection of neutral and protective cables (N and PE) is dangerous for persons performing measurement and outside persons. It is obligatory to connect protective and neutral cables to the network immediately after measurements!

If disconnection is not possible one needs to use the meter from MRU family.

## 5 Remote control of the meter

- Connect the meter to the Wi-Fi network and obtain its Internet address (sec. 7.4).

```
Wi-Fi transmission
OK
Web address:
http:// 192.168.100.149
or: http:// mzc-320s.local
```

- Use an external device to connect to the same network as the meter and enter the address of the instrument in the web browser. Its web interface will be displayed. It shows the currently set position of the instrument's knob.



- To trigger the measurement remotely, enter the measurement menu of the meter. Then touch the padlock in the application to unlock the option of measurement and then press **START**.





Successful memory entry is signalled with the symbol  $\Rightarrow$  displayed on the screen and three short beeps are produced.

While filling the last cell in the given bank, instead of displaying the symbol  $\Rightarrow$ , the screen will show a text: **Last cell in the bank!**

## 6.2 Memory browsing

In order to view the measurement results stored in the memory, the user should set the rotary switch to the position **MEM**. Choose **Review** from the menu. The screen will display the contents of the recently filled cell.

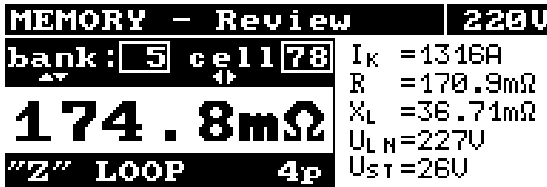


Fig. 28 Memory browsing

Using the keys  $\blacktriangle$  and  $\blacktriangledown$  the user can select the bank number he/she wishes to review, and using the keys  $\blacktriangleleft$  and  $\blacktriangleright$  the cell number. If the cell is not filled, horizontal lines will be displayed instead of the memory cell contents.

## 6.3 Memory erasing

You can erase the whole memory, individual banks or single cells. In order to delete a cell you need to:

- set the rotary switch to the **MEM** position,
- select **Delete cell**,
- using keys  $\blacktriangle$  and  $\blacktriangledown$  choose the bank number and using keys  $\blacktriangleleft$  and  $\blacktriangleright$  the cell number you want to delete,

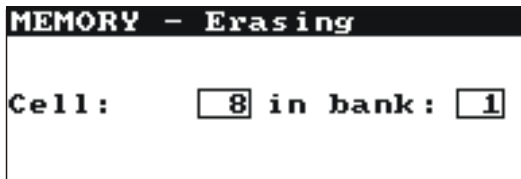


Fig. 29 Deleting a memory cell: 1 – bank No, 8 – cell No,  – bank with at least one cell used,  – a cell in use

- press the key **ENTER**, the screen will display a prompt asking if you want to erase the cell,
- after selecting the **YES** option, press the key **ENTER**, the screen will display a message: **Deletion of the selected cell** as well as a progress bar. When deletion is completed a message will be displayed: **Cell deleted!** and the meter will produce three short beeps.

In order to delete an entire bank you need to:

- set the rotary switch to the **MEM** position,
- select **Bank deletion**,
- using the keys  $\blacktriangle$  and  $\blacktriangledown$  select the bank number,



- press the key **ENTER**, the screen will display a prompt asking if you want to erase the entire bank,
- after selecting the **YES** option, press the key **ENTER**; the screen will display a message: **Deletion of the whole bank** and a progress bar. When deletion is completed, a message will be displayed: **Bank deleted!** and the meter will produce three short beeps.

In order to delete the whole memory you need to:

- set the rotary switch to the **MEM** position,
- select **Memory deletion** from the menu,
- press the key **ENTER**, the screen will display a prompt asking whether you want to erase the whole memory,
- after selecting **YES**, press the key **ENTER**; the screen will display a message: **Deletion of the whole memory** and a progress bar. When deletion is completed, a message will be displayed: **Whole memory deleted!** and the meter will produce three short beeps.

In order to cancel the deletion, press the key **ESC**.

## 7 Data transmission

### 7.1 Set of accessories to connect the meter to a PC

In order to interface the meter with a computer an optional communications kit is required: a serial cable or Bluetooth module and appropriate software. If the software package has not been ordered together with the meter, it can be purchased from the manufacturer or from an authorized distributor.

The software package can be used to communicate with a range of instruments manufactured by SONEL S.A. that are equipped with an USB connection.

Detailed information about the software is available from the manufacturer and the distributors.

### 7.2 Data transmission via USB

- Connect the communications cable to USB port of the computer and to the USB socket of the meter.
- From the **MENU** select **Data transmission** and then **USB transmission**.
- Start the software.
- Start the software to read /save data and proceed in accordance with its instructions.

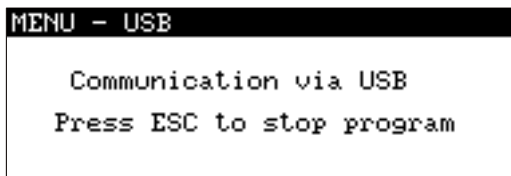


Fig. 30 Screen of communication via USB

## 7.3 Data transmission via Bluetooth



Bluetooth transmission is available in meters with a serial number having the **EC** and **ED** prefix.

### 7.3.1 Activation and transmission

- Activate Bluetooth on your PC (if it is an external module, it must be connected to the computer before). Follow the instructions of the module.
- Turn on the meter and in **MENU** select the position **Bluetooth transmission**.
- On a PC enter Bluetooth connectivity mode, select MZC-320S or MZC-330S device and establish the connection.

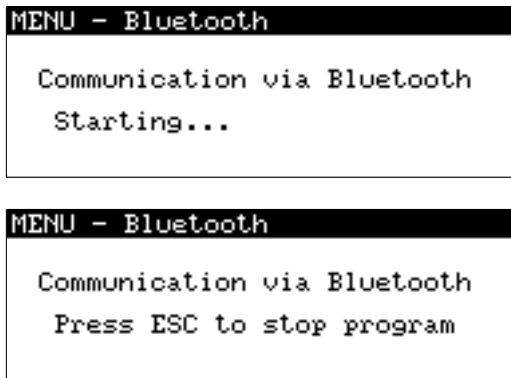


Fig. 31 Screen of communication via Bluetooth

- Start the software to read /save data and proceed in accordance with its instructions.

### 7.3.2 Read-out and change of PIN code for Bluetooth

- In **MENU** select position: **Data transmission** and then **Bluetooth – set PIN** ,
- using keys ◀ and ▶ move to the next digit, using keys ▲ and ▼ change its value,
- press **ENTER** to confirm.



Fig. 32 Changing the PIN code



Standard PIN code for Bluetooth transmission is "0000".

## 7.4 Data transmission using Wi-Fi



Wi-Fi transmission is available in meters with a serial number having the **MS** and **MT** prefix.

### 7.4.1 Activation of transmission

- Turn on the meter and from **MENU** select: **Data transmission ► Wi-Fi transmission**.
- Turn on Wi-Fi (**ENTER**).
- Select **Network search**. Message **Network search...** will be displayed
- From the list of detected networks, select the one you want to connect to. If it is password protected, enter the password. Use **◀▶** buttons to move to the next letter and confirm it with the **ENTER** button. Use **▲▼** buttons to go to the line below, where the command to be executed is selected using **◀▶**.

```
Found Wi-Fi
gosc
unifi
DJ0006
↓ 4815162342
```

```
Connecting to gosc
Password:
_ ' a b c d e f g h i j k
Delete Connect
```

- Select **Connect** and press **ENTER**.
- In the Wi-Fi transmission menu, select the **Web server** item. A series of messages will appear, which must be confirmed by pressing **ENTER**.
- Finally, the address of the meter in the network to which it is connected will be displayed.

```
Wi-Fi transmission
OK
Web address:
http:// 192.168.100.149
or: http:// mzc-320s.local
```

Fig. 33 Addresses for MZC-320S



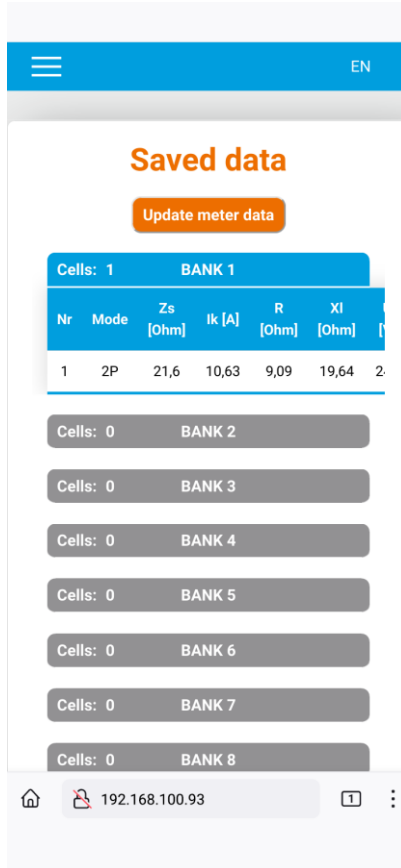
After restarting the meter, it automatically logs into the network to which it was previously connected.

### 7.4.2 Transmission to PC software

- Start the software to read /save data and proceed in accordance with its instructions.

### 7.4.3 Transmission via the network interface

- Use an external device to connect to the same network as the meter and enter the address of the instrument in the web browser. Its web interface will be displayed.
- Go to the **DATA** tab.
- Download the data stored in the meter's memory (**Update meter data**). Each bank containing measurement data will have a blue label. This label can be expanded to display individual results.
- To save the data to a CSV file, scroll down the page and select **Download the csv file**.



#### 7.4.3.1 Changing the language of the web interface

The current language of the web interface is shown in the upper right corner. To change it, tap this field. Then a list of interface languages will appear, from which you can choose a different one. If the change doesn't work, just refresh the page in your browser.

## 8 Troubleshooting

### 8.1 Warnings and information displayed by the meter

MZC-320S and MZC-330S devices display warnings that can be related to either its functioning or to external conditions affecting the measurement processes.

#### 8.1.1 Exceeding the measurement range

Text displayed	Audible signal	Reason	Action
<b>U &gt; 550V!</b> or <b>U &gt; 750V!</b> (MZC-330S)	Continuous	Voltage measured exceeds 550 V (750 V for MZC-330S)	<b>Immediately disconnect the meter from the network!</b>
<b>OFL</b>	Two long beeps	Short-circuit loop resistance exceeds 2 $\Omega$ (4p)	
<b>OFL</b>	Two long beeps	Short-circuit loop resistance exceeds 200 $\Omega$ (2p)	

#### 8.1.2 Battery status display

Text displayed	Reason	Action
<b>Bat !</b>	Battery is discharged.	Charge the battery.

### 8.2 Self-test error messages

If, as a result of the self-test, the instrument detects an error, it stops the normal operation and displays an error message. The following messages can appear:

- **Internal error**
- **Damaged FLASH kernel!**
- **Damaged calibration data**

The message that appears may be caused by a momentary interference or an external factor. You should therefore switch the device off and then on to determine if this is the case. If the problem persists, the device should be sent to a service agent.

### 8.3 Before you send the device for repairs

Before you send the device to a service agent, you should contact the technical support to ensure that the problem is a result of a fault and is not caused by some other factors.

The repairs should be carried out only by service agents authorised by the manufacturer.

In the table below you will find the procedures that should be followed in a case of a malfunction.

Symptom	Reason	Action
The meter does not switch on with the push-button <b>ON/OFF</b> . While measuring, the symbol <b>Bat !</b> is displayed.	Battery is discharged.	Make sure that the battery is not discharged. Try charging the battery. If the problem persists send the device to the service agent.
Consecutive results obtained in the same measuring point differ markedly.	Faulty connection in the installation being tested	Find and remove faulty connections.
	Installation with a high level of interference or unstable voltage.	Perform more measurements. Average the results. Use the MENU option: „Expected declension (dispersion)” (see sec. 3.5.1).
Measurement errors when the device is moved from a cold to a warm and humid environment.	Need for acclimatizing.	Do not use the device until it reaches the ambient temperature (approx. 30 min) and dries out.
The meter shows values close to zero or zero irrespective of the measurement place, and the values deviate considerably from the anticipated values.	Fault in the short circuit loop.	Send the device to a service agent.

## 9 Power supply of the meter

### 9.1 Power supply voltage monitoring

The battery charge is shown by the indicator located in the upper right corner of the display as shown in figure below.

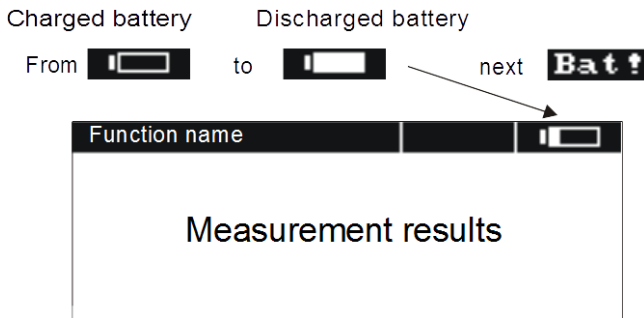


Fig. 34 Battery charge indicator

## 9.2 Charging battery

Charging commences after connecting the meter to the power supply, regardless of the fact if the meter is switched on or off. Full charging time for completely discharged battery take approx. nine hours.

The charging process is indicated by LED diode:

- steady red light slow blinking: charging in progress,
- steady green light: end of charging,
- flashing - red / green: charging suspended. Cause: battery pack temperature is too low or too high.

## 9.3 General principles for using Li-Ion rechargeable batteries

- Store the meter with built-in rechargeable battery for a long time with the battery half-charged in a dry, cool and well ventilated place and protect them from direct sunlight. The battery pack may be damaged if stored when fully discharged. The ambient temperature for prolonged storage should be maintained within the range of 5°C...25°C.

- Charge the batteries in a cool, well-ventilated place at a temperature of 10°C ... 28°C. Modern fast chargers detect both too low and too high temperature of rechargeable batteries and react to the situation adequately. Too low temperature should prevent starting the process of charging, which might irreparably damage rechargeable batteries. The increase in temperature of the battery pack may cause electrolyte leakage and even its ignition or explosion.

- Do not exceed the charging current, as it may result in ignition or "swelling" of the battery pack. "Swollen" battery pack must not be used.

- Do not charge or use the batteries in extreme temperatures. Extreme temperatures reduce the life-time of rechargeable batteries. Always observe the rated operating temperature. Do not dispose the battery pack into fire.

- Li-Ion cells are sensitive to mechanical damage. This kind of damage may cause its permanent damage and thus - ignition or explosion. Any interference in the structure of Li-ion battery pack may cause its damage. This may result in the ignition or explosion. A short-circuit of the battery poles "+" and "-" may permanently damage the battery pack or even cause its fire or explosion.

- Do not immerse Li-Ion battery in liquids and do not store in humid conditions.

- If the electrolyte contained in the Lithium-Ion battery pack, contacts eyes or skin, immediately rinse the affected place with plenty of water and consult a doctor. Protect the battery against unauthorised persons and children.

- When you notice any changes in the Lithium-Ion battery pack (e.g. changes in colour, swelling, excessive temperature), stop using the battery pack. Li-Ion batteries that are mechanically damaged, overcharged or excessively discharged are not suitable for use.

- Any misuse of the battery may cause its permanent damage. This may result in the ignition. The seller and the manufacturer shall not be liable for any damages resulting from improper handling Li-Ion battery pack.

## 10 Cleaning and maintenance



### NOTE!

Use only the maintenance methods presented by the manufacturer in this manual.

Clean the meter casing and the case with a wet cloth, using generally available detergents. Do not use any solvents and cleaning media which could scratch the casing (powder, paste, etc.).

The meter electronic system is maintenance free.

## 11 Storage

When storing the instrument, observe the following recommendations:

- disconnect all leads from the meter,
- thoroughly clean the meter and all accessories,
- wind long test leads onto the spools,
- during a prolonged storage recharge the batteries from time to time to prevent total discharging.

## 12 Dismantling and disposal

Used electric and electronic equipment should be collected selectively, i.e. not placed with other types of waste.

Used electronic equipment shall be sent to the collection point according to the Used Electric and Electronic Equipment Act.

Before sending the instrument to the collection point, do not dismantle any parts by yourself. Observe local regulations on disposal of packagings and used batteries.

## 13 Technical specifications

### 13.1 Basic data

⇒ Abbreviation "m.v" used in the specification of accuracy means a standard measured value

#### Voltage Measurement (True RMS)

	Range	Resolution	Accuracy
MZC-320S	0 V...550 V	1 V	$\pm(2\% \text{ m.v.} + 2 \text{ digits})$
MZC-330S	0 V...750 V	1 V	$\pm(2\% \text{ m.v.} + 2 \text{ digits})$

- Frequency range: DC, 45 Hz...65 Hz
- Input impedance of the voltmeter:  $\geq 200 \text{ k}\Omega$

#### Frequency Measurement (for voltages $\geq 50 \text{ V}$ )

Range	Resolution	Accuracy
45.0 Hz...65.0 Hz	0.1 Hz	$\pm(0.1\% \text{ m.v.} + 1 \text{ digit})$



## Short-Circuit Loop Parameters Measurement Using High Current (4p, I<sub>max</sub>=300 A)

### Measurement of short-circuit loop impedance Z<sub>s</sub>

Measurement range in accordance with IEC 61557.....7.2 mΩ ±1999 mΩ

#### Display Range Z<sub>s</sub>

Range	Resolution	Accuracy
0.0 mΩ...199.9 mΩ	0.1 mΩ	±(2% m.v. + 2 mΩ)
200 mΩ...1999 mΩ	1 mΩ	

### Short-Circuit Resistance R<sub>s</sub> and reactance X<sub>s</sub> Display Range

Range	Resolution	Accuracy
0.0...199.9 mΩ	0.1 mΩ	±(2% + 2 mΩ) of Z <sub>s</sub> value
200...1999 mΩ	1 mΩ	

### Short-Circuit Current Readings I<sub>k</sub>

Measurement range in accordance with IEC 61557:

for U<sub>n</sub> = 115 V..... 57,5 A ÷ 15,9 kA

for U<sub>n</sub> = 230 V.....115,0 A ÷ 32,9 kA

for U<sub>n</sub> = 400 V.....200 A ÷ 55,5 kA

for U<sub>n</sub> = 500 V.....250 A ÷ 69,4 kA

for U<sub>n</sub> = 690 V.....345 A ÷ 95,8 kA (only MZC-330S)

#### Display Range I<sub>k</sub>

Range	Resolution	Accuracy
115.0 A...199.9A	0.1 A	Calculated from the short-circuit accuracy
200 A...1999 A	1 A	
2.00 kA...19.99 kA	0.01 kA	
20.0 kA...199.9 kA	0.1 kA	
200 kA...*	1 kA	

\* max. 500 kA for MZC-320S or max. 690 kA for MZC-330S

- Prospective fault current calculated and displayed by the meter may slightly differ from the value calculated by the user with a calculator, basing on the displayed value of the impedance, because the meter calculates the current from unrounded value of fault loop impedance (which is used for displaying). As the correct value, consider I<sub>k</sub> current value, displayed by the meter or by firmware.

### Touch Voltage Measurement U<sub>ST</sub> (shock voltage U<sub>T</sub>)

Range	Resolution	Accuracy
0 V...100 V	1 V	±(10% m.v. + 2 digits)

- For U<sub>T</sub> – resistor simulating electrical resistance of the human body – 1kΩ

## Measurement of Short-Circuit Loop Using Standard Current (2p)

### Measurement of short-circuit loop impedance Z<sub>s</sub>

Measurement range in accordance with IEC 61557

Test lead	Z <sub>s</sub> measurement range
1.2 m	0.13 Ω...199.9 Ω
5 m	0.15 Ω...199.9 Ω
10 m	0.19 Ω...199.9 Ω
20 m	0.25 Ω...199.9 Ω

### Display range $Z_s$

Range	Resolution	Accuracy
0.00 $\Omega$ ...19.99 $\Omega$	0.01 $\Omega$	$\pm(2\% \text{ m.v.} + 3 \text{ digits})$
20.0 $\Omega$ ...199.9 $\Omega$	0.1 $\Omega$	$\pm(3\% \text{ m.v.} + 3 \text{ digits})$

### Short-Circuit Resistance $R_s$ and reactance $X_s$ Display Range

Range	Resolution	Accuracy
0.00 $\Omega$ ...19.99 $\Omega$	0.01 $\Omega$	$\pm(2\% \text{ m.v.} + 3 \text{ digits})$ impedance reading for a particular measurement
20.0 $\Omega$ ...199.9 $\Omega$	0.1 $\Omega$	$\pm(3\% \text{ m.v.} + 3 \text{ digits})$ impedance reading for a particular measurement

### Short-Circuit Current Readings $I_k$

Measurement ranges in accordance with IEC 61557

Test Lead	$I_k$ measurement range for $U_n = 230 \text{ V}$	$I_k$ measurement range for $U_n = 400 \text{ V}$
1.2 m	1.150 A...1849 A	2.00 A ...3,21 kA
5 m	1.150 A...1539 A	2.00 A ...2,67 kA
10 m	1.150 A...1262 A	2.00 A ...2,19 kA
20 m	1.150 A...924 A	2.00 A ...1607 A

- Prospective fault current calculated and displayed by the meter may slightly differ from the value calculated by the user with a calculator, basing on the displayed value of the impedance, because the meter calculates the current from unrounded value of fault loop impedance (which is used for displaying). As the correct value, consider  $I_k$  current value, displayed by the meter or by firmware.

### Display ranges

Display range	Resolution	Accuracy
1.150 A...1.999 A	0.001 A	Calculated from the short-circuit accuracy
2.00 A...19.99 A	0.01 A	
20.0 A...199.9 A	0.1 A	
200 A...1999 A	1 A	
2.00 kA...19.99 kA	0.01 kA	
20.0 kA...40.0 kA	0.1 kA	

### Working Conditions

- Rated voltage of tested circuits  $U_n$ :
  - Phase voltage – MZC-320S ..... 110 V, 115 V, 127 V, 220 V, 230 V, 240 V, 290 V
  - Phase voltage – MZC-330S ..... 110 V, 115 V, 127 V, 220 V, 230 V, 240 V, 290 V, 400 V
  - Phase-to-phase voltage – MZC-320S ..... 190 V, 200 V, 220 V, 380 V, 400 V, 415 V, 500 V
  - Phase-to-phase voltage – MZC-330S ... 190 V, 200 V, 220 V, 380 V, 400 V, 415 V, 500 V, 690 V
- Voltage range for loop testing
  - MZC-320S ..... 95 V...550 V
  - MZC-330S ..... 95 V...750 V
- Rated frequency of tested circuits ..... 50 Hz and 60 Hz (45 Hz...65 Hz)

### Maximum test current (2p)

- for 230 V ..... 24 A (10 ms)
- for 400 V ..... 21 A (10 ms)
- for 500 V ..... 27 A (10 ms)
- for 690 V ..... 37 A (10 ms)

### Maximum test current (4p)

- for 230 V ..... 130 A (20 ms)
- for 400 V ..... 220 A (20 ms)
- for 500 V ..... 280 A (20 ms)
- for 690 V (only MZC-330S) ..... 280 A (20 ms)

## 13.2 Other technical data

- a) Insulation class acc. to EN 61010-1 and EN 61557 ..... double
- b) Metrological category acc. to EN 61010-1 ..... IV 600 V
- c) Housing protection class as per EN 60529 ..... IP67 with closed case, IP20 with open case
- d) Meter power supply ..... built-in Li-Ion rechargeable battery 7.2 V 8.8 Ah
- e) Dimensions ..... 390 x 308 x 172 mm
- f) Weight ..... ca. 6.5 kg
- g) Storage temperature ..... -20°C...+60°C
- h) Operating temperature ..... -10°C...+40°C
- i) Humidity ..... 20%...90%
- j) Rated temperature ..... +23°C ± 2°C
- k) Reference humidity ..... 40%...60%
- l) Altitude (above sea level) ..... <2000 m
- m) Time before automatic shutdown ..... 10 min.
- n) Number of short-circuit loop measurements ..... min. 4000 (2 measurements/min.)
- o) Display ..... graphical LCD 192 x 64 dots
- p) Quality standard ..... development, design and manufacturing to ISO 9001 compliant
- q) The instrument meets the requirement of the ..... IEC 61557 standard
- r) The product meets EMC requirements (immunity for industrial environment) according to the following standards ..... EN 61326-1 and EN 61326-2-2



### EN 55022 Compliance statement

MZC-320S and MZC-330S are class A products. In a domestic environment these products may cause radio interference in which case the user may be required to take adequate measures (e.g. increasing the distance between affected products).



SONEL S.A. hereby declares that the radio device type MZC-320S/330S complies with Directive 2014/53/EU. The full text of the EU Declaration of Conformity is available at the following website address: <https://sonel.pl/en/download/declaration-of-conformity/>

### 13.3 Additional data

Data on additional uncertainties are useful mainly when the meter is used in non-standard conditions and for metrological laboratories for the purpose of calibration.

#### 13.3.1 Additional uncertainties according to IEC 61557-3 (Z)

Significant parameter	Designation	Additional uncertainty
Position	E <sub>1</sub>	0%
Supply voltage	E <sub>2</sub>	0% (BAT is not lit)
Temperature 0°C...35°C	E <sub>3</sub>	1.2 m lead – 0 Ω 5 m lead – 0.011 Ω 10 m lead – 0.019 Ω 20 m lead – 0.035 Ω WS-01 lead, WS-05 – 0.015 Ω
Phase angle 0°...30° at the bottom of test range	E <sub>6.2</sub>	0.6%
Frequency 99%..101%	E <sub>7</sub>	0%
Network voltage 85%..110%	E <sub>8</sub>	0%
Harmonic	E <sub>9</sub>	0%
DC component	E <sub>10</sub>	0%

## 14 Manufacturer

The manufacturer of the device provides all warranty and after-warranty repairs:

**SONEL S.A.**

Wokulskiego 11  
58-100 Świdnica  
Poland

tel. +48 74 884 10 53 (Customer Service)

e-mail: [customerservice@sonel.com](mailto:customerservice@sonel.com)

web page: [www.sonel.com](http://www.sonel.com)



Only the manufacturer is authorized to carry out service repairs.

## NOTES

## NOTES





**SONEL S.A.**

Wokulskiego 11  
58-100 Świdnica  
Poland

**Customer Service**

tel. +48 74 884 10 53  
e-mail: [customerservice@sonel.com](mailto:customerservice@sonel.com)

[www.sonel.com](http://www.sonel.com)